

USER MANUAL

FLOSTOP Lead Free Brass Valves

- **TFTLF1010** - Lead Free DZR Brass Wall Mounted Single Temperature Timed Flow Control Valve
- **TFTLF1010ADJ** - Lead Free DZR Brass Wall Mounted Shower/Control Valve with Chrome Plated Concealed Connection - Adjustable Timing Free Flow
- **TFTLF1015** - Lead Free DZR Brass In-Wall Single Temperature Timed Flow 15mm Male Shower Set w/ Recess Stainless Steel Enclosure
- **TFTLF1016** - Lead Free DZR Brass In-Wall Hot and Cold Temperature Timed Flow Shower Mixer w/ Concealed Stainless Steel Enclosure
- **TFTLF3500** - Lead Free DZR Brass Wall Mounted 15mm Male Knee Operated Valve w/ Knee Wand Attachment
- **TFTLF3500KIT** - Lead Free DZR Brass Wall Mounted Single Temperature Timed Flow Knee Operated Valve w/ Knee Wand Attachment and Fixed Basin Spout



USER MANUAL

Table of Contents

Scope of Use	2
Technical Information	3
Exploded Drawings	4
Product Images & Technical Drawings	6
Installation Steps	9
Time Adjustment	13
Cleaning & Maintenance	14
Spare Parts	16
Troubleshooting	17
Water Quality	18
Responsibly Sourced	19

Scope of Use

Installation of all products should adhere to the manufacturer's guidelines, as well as comply with PCA, AS/NZS3500 standards, and any other relevant regulatory provisions. This product range complies with the Lead Free requirements of the National Construction Code Volume Three.

- **Installation:** Refer to the installation instructions included within this manual
- **Water quality:** In line strainer (supplied) must be installed to ensure water quality
- **Suitable for indoor and outdoor use**
- **Temperature recommendation:**
 - Single temperature up to: 50°C
 - Dual temperature up to: 60°C
 - Minimum temperature: 5°C
- **Mounting:** Wall or in line installation

Technical Information

Material	<ul style="list-style-type: none"> · TFTLF1015 & TFTLF1016: (Valve: Lead Free DZR Brass, Enclosure: Stainless Steel) · TFTLF1010, TFTLF1010ADJ, TFTLF3500 & TFTLF3500KIT: Lead Free DZR Brass
Cartridge	Timed Flow (Hydraulic)
Cartridge Size	15mm
Inlet	15mm Male
Outlet	<ul style="list-style-type: none"> · TFTLF1015: Single Temperature Timed Flow 15mm Male Outlet · TFTLF1016: Mixed Temperature Timed Flow 15mm Male Outlet · TFTLF3500: 15mm Male · TFTLF3500KIT: Single Temperature Timed Flow
Flow Style	<ul style="list-style-type: none"> · TFTLF1015 & TFTLF1016: Free Flow · TFTLF3500: 15mm Male (G 1/2" BSP) · TFTLF3500KIT: Aerated Flow
Run Time	<ul style="list-style-type: none"> · TFTLF1015 & TFTLF1016: 0-40 (+/- 10) Seconds (Adjustable) · TFTLF3500: 15 (+/- 2) seconds (Fixed) · TFTLF3500KIT: 15 seconds (Fixed)
Working Pressure	150kPa-500kPa
Recommended Working Pressure	350kPa
Working Temperature	5°C - 50°C
Finish / Colour	Chrome Plated

USER MANUAL

Exploded Drawings

TFTLF3500KIT

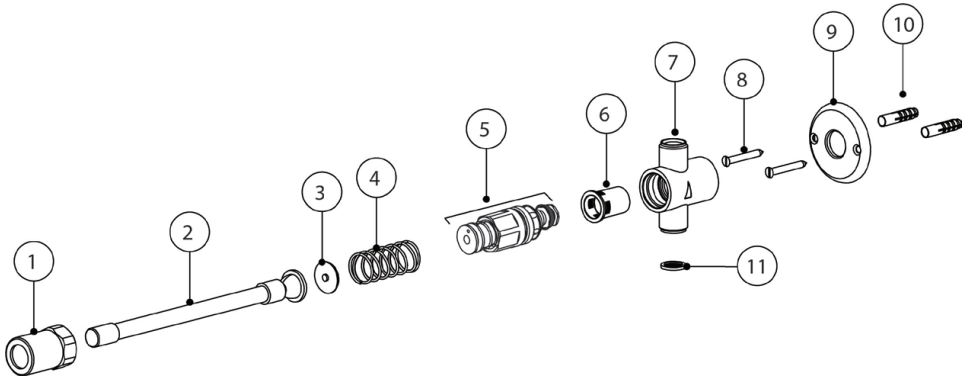

Item#	Description	Qty	Spare Parts
1	Headvalve Holder	1	<input checked="" type="checkbox"/>
2	Plastic Lever Knee Wand	1	<input checked="" type="checkbox"/>
3	Flat Brass Spacer	1	<input checked="" type="checkbox"/>
4	Spring	1	<input checked="" type="checkbox"/>
5	Cartridge	1	<input checked="" type="checkbox"/>
6	Flow Cup	1	<input checked="" type="checkbox"/>
7	Valve Body	1	<input type="checkbox"/>
8	Fixing Screws	2	<input type="checkbox"/>
9	Flange	1	<input type="checkbox"/>
10	Wall Plugs	2	<input type="checkbox"/>
11	Strainer (TFT9070)	1	<input type="checkbox"/>
12	O-Ring Kit (TFT9060)	Preventative Maintenance	<input checked="" type="checkbox"/>

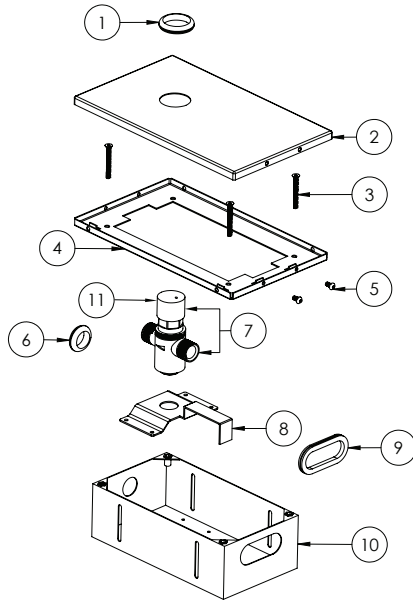
TFTLF1015

Item#	Description	Qty	Spare Parts
1	Valve Rubber Grommet	1	<input type="checkbox"/>
2	Cover Plate (2 options of lids)	1	<input checked="" type="checkbox"/>
3	M4 x 40mm Countersunk Screws	4	<input type="checkbox"/>
4	Fixing Plate	1	<input type="checkbox"/>
5	M4 x 8mm Buttonhead Antivandal Screws	3	<input type="checkbox"/>
6	Circular Grommet	1	<input type="checkbox"/>
7	TFTLF1015 Valve	1	<input checked="" type="checkbox"/>
8	Support Valve	1	<input type="checkbox"/>
9	Oval Grommet	1	<input type="checkbox"/>
10	TFT1015/6 Box	1	<input checked="" type="checkbox"/>
11	Time Flow Cartridge	1	<input checked="" type="checkbox"/>

USER MANUAL

Product Images & Technical Drawings

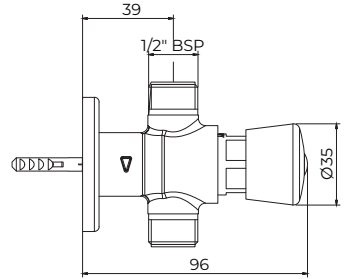
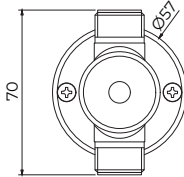

TFTLF1010

Lead Free DZR Brass Wall Mounted Single Temperature Timed Flow Control Valve

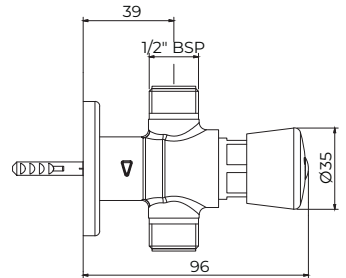
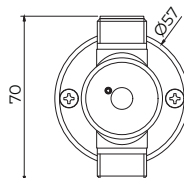

TFTLF1010ADJ

Lead Free DZR Brass Wall Mounted Shower/Control Valve with Chrome Plated Concealed Connection - Adjustable Timing Free Flow

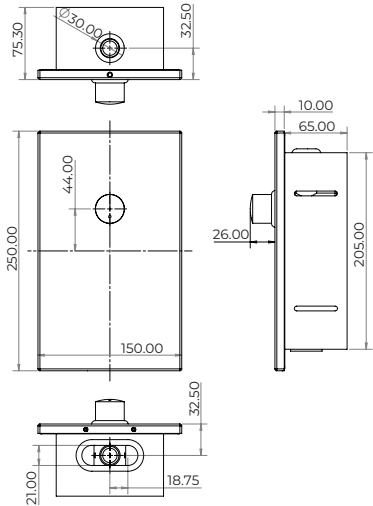
TFTLF1015

Lead Free DZR Brass In-Wall Single Temperature Timed Flow 15mm Male Shower Set w/ Recess Stainless Steel Enclosure

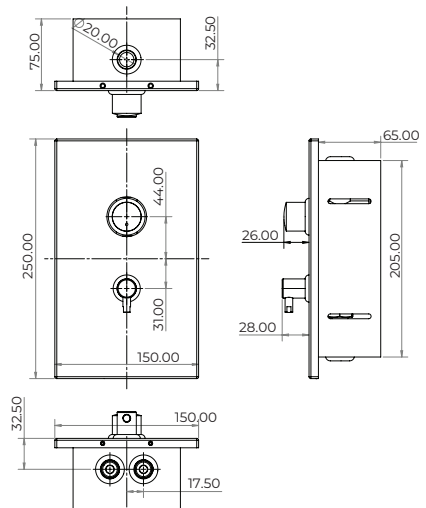
TFTLF1016

Lead Free DZR Brass In-Wall Hot and Cold Temperature Timed Flow Shower Mixer w/ Concealed Stainless Steel Enclosure

Installation Steps

BEFORE THE SET UP

- Valves must be installed to the requirements of AS/NZ 3500 by a qualified and licenced plumber.
- Flush the water lines and clear the debris from the line before connecting the water supply line to the valve.
- All products must be installed with isolation valves.
- Working pressure must be between 150kPa and 500kPa.
- Direct ablution temperature must be between 5°C and 50°C.
- For shower valves, ensure that the button on the valve body is aligned with the water flow direction.
- The valve comes to you already is factory assembled and tested. We do not recommend dismantling any internal part of the valve. The valves are factory tested and sealed to give the best performance.
- Product should be mounted free of obstructions.
- Do not modify the product.
- The foot pedal must be mounted at a height of 70 mm or lower from the floor.

TFTLF1010, TFTLF1010ADJ INSTALLATION STEPS

Step 1. Flush the new pipe prior to installation.

Step 2. Install the strainer.

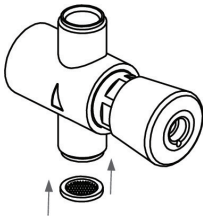

Step 3. Measure and mark the two holes, use the fixing flange for drilling into the wall.

Step 4. Screw the valve body to the flange.

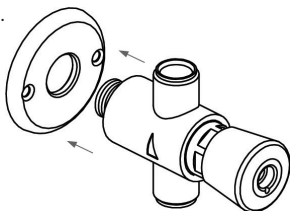

Step 5. Ensure the arrow on the valve body is facing the direction of the outlet.

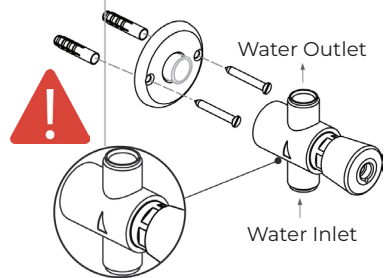

Step 6. Connect the water inlet and outlet.

USER MANUAL

- Step 7. Push the colour indicator for hot or cold water into the button.

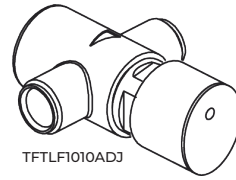
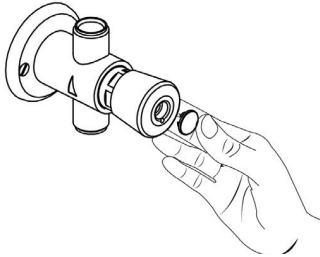

The difference between the TFTLF1010 and the TFTLF1010ADJ is only the cartridge. The TFTLF1010ADJ has an adjustable cartridge.

TFTLF1015 INSTALLATION STEPS

- Step 1. Mount the stainless box into the wall firmly.

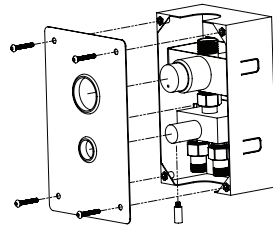
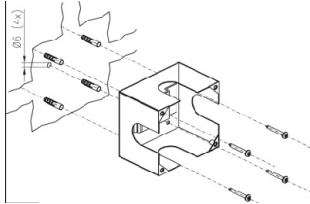

- Step 2. Screw the main valve into the box and locate the outlet in the vertical position. Ensure the arrow on the valve body is facing the direction of the outlet.

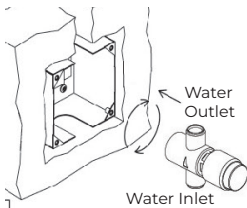

- Step 3. All screwed fittings connected to the valve can be easily dismantled so the main valve can be removed.

- Step 4. It is recommended to use flat union connections.

- Step 5. Ensure to cover the stainless steel box flush with the finished wall this includes tiles, waterproofing, etc. Please ensure that the wall components are sealed and waterproof to avoid water/moisture penetration.

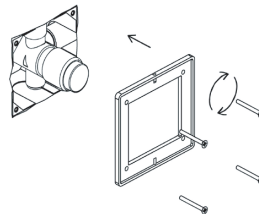

Step 6. Attach the adjustment cover (5) to the box, ensure adequate sealant is applied to both cover and box to avoid water penetration.

Step 7. To finish off the installation, fit rubber to the stainless-steel front cover plate.

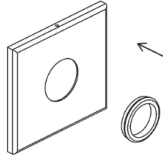

Step 8. The stainless-steel cover plate comes with two grub screws. Push the cover plate over the button against the adjustment cover, then screw the two grub screw in place to secure the stainless steel cover plate.

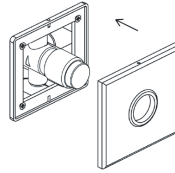

TFTLF3600 INSTALLATION STEPS

Choose the position that suits better (floor or wall mounted)

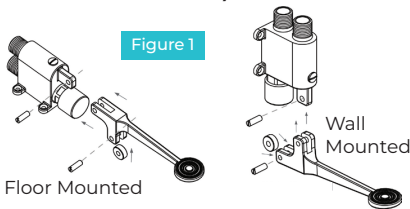

Steps to Convert the pedal valve from floor mounted to wall mounted:

- Step 1. Remove the screw on the pedal lever.
- Step 2. Reverse the pedal lever as shown in Figure 1.
- Step 3. Mount the unit securely (floor or wall) to prevent any movement while operating the valve
- Step 4. Use the four mounting screws to screw the pedal valve into place.

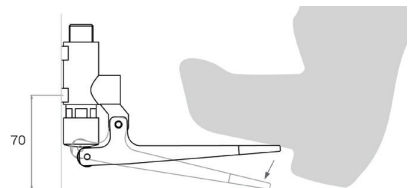
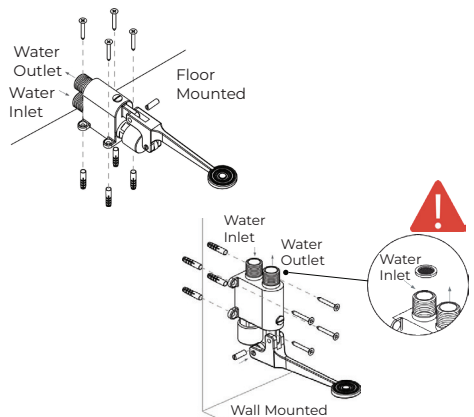

USER MANUAL

TFTLF3500KIT INSTALLATION STEPS

- Step 1. Ensure the nipple is facing towards the knee valve wand.

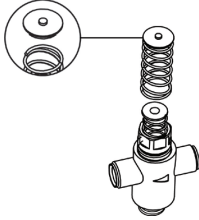

- Step 2. Slide the head valve holder over the knee valve wand and screw on to the cartridge.

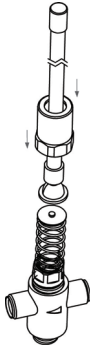

Mounting the knee valve to the wall:

- Step 3. Screw on the knee valve body to the flange.
- Step 4. Using the necessary screws to mount firmly to the wall.
- Step 5. Ensure the arrow on the knee valve body (figure 2) is facing up when connected to the water inlet and outlet.
- Step 6. Place the filter in the water inlet and use flat union connectors to prevent damaging the strainer.
- Step 7. Do not over-tighten the cartridge.

Time Adjustment

2 TO 40 SECONDS

This option is suitable for the following references: TFTLF1010ADJ, TFTLF3600, TFTLF1015.

- To adjust the timing, you will need to use the allen key provided or you need a 1.2mm allen key.

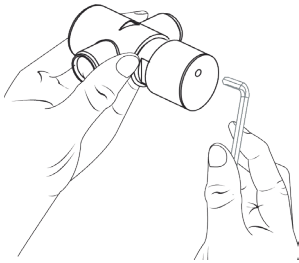

- Turning the screw clockwise will reduce the run time.

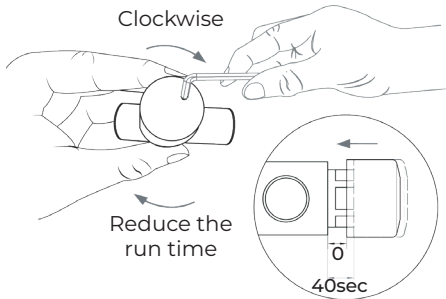

- Turning the screw anti clockwise will increase the run time

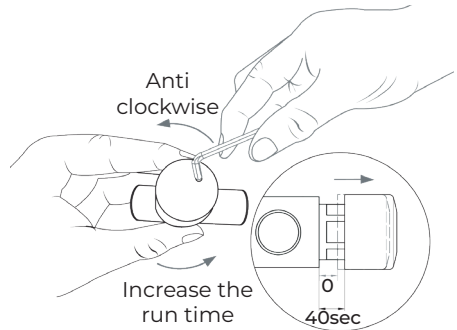

Contact GENTEC before changing flow cups

Our FLOSTOP range is available in the following fixed timing options.

These options are available upon request and are factory installed.

Changing the flow cup yourself may void the product warranty.

Flow Control Cup	Description
TFT9050	Flow cup 4 - 6 Sec
TFT9052	Flow cup 8 - 12 Sec
TFT9053	Flow cup 12 - 16 Sec
TFT9054	Flow cup 40 Sec

USER MANUAL

Cleaning & Maintenance

To minimise downtime and maximise the functional life of the product, GENTEC recommends servicing your product at least every 12 months, under heavy use may need to be checked and serviced more often.

- The product must be handled carefully to avoid causing any physical damage.
- Use the product at least once every week to ensure all parts are kept lubricated and functioning properly.
- Service the product at least once a year to avoid any product failures - The service timeline provided is based on normal use. More frequent servicing may be required for heavy usage.
- A working pressure of 350kPa is highly recommended to ensure the maximum up-time of the product.
- Regularly clean the product with a soft cloth with warm soapy water, wash off with warm water and dry off with a soft dry cloth, paying attention to removing the dust and contamination in the bends and joints is highly recommended.
- Abrasives, hard clothes, strong acids, and bleaches must be avoided when cleaning all GENTEC products.

Code	Description
TFT9050	Flow cup 4 - 6 Sec
TFT9052	Flow cup 8 - 12 Sec
TFT9053	Flow cup 12 - 16 Sec
TFT9054	Flow cup 40 Sec
TFT9010	Cartridge to fit TFT1010
TFT9069	Adjustable cartridge
TFT9300	Knee operated wand
TFT9304	Knee operated cartridge

O-Ring Code	Components Included	Qty
TFT9060	O-Ring	2
	Washer Gaco	2

O-RING KIT SERVICE

Important Note

For the following steps, a qualified plumber must be in charge of the maintenance and handling of the tapware in order to keep product warranty. The damage on parts after dismantling a product would not be covered by the warranty.

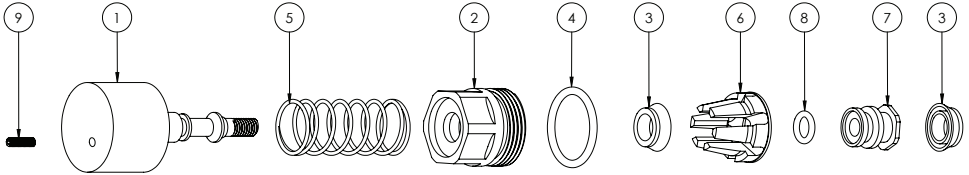

No.	Description	Qty.
01	Handle & Stem	1
02	Head Valve	1
03	Gaco	2
04	Large O-Ring	1
05	Spring	1

Step 1. Start by shutting off the main water supply.

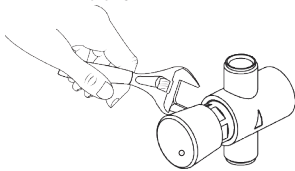

Step 2. Unscrew the head valve using a shifter on the flats to remove the cartridge.

Step 3. Undo the stopper.

Step 4. Set aside the crown ring.

Step 5. Set aside the head valve from the stem.

Step 6. Remove the washer Gaco from the head valve and replace with the new washer Gaco.

No.	Description	Qty.
06	Crown Ring	1
07	Stopper	1
08	Small O-Ring	1
09	Adjusting Screw	1

Step 7. Remove the other washer Gaco from the stopper and replace it with the new washer Gaco.

Step 8. Remove the O-Ring and replace it with the new O-Ring.

Step 9. Remove the other O-Ring and replace it with the new O-Ring.

Step 10. Using the existing crown ring place it back into the head valve.

Step 11. Place the stem through the head valve.

Step 12. Apply a drop of Loxeal to the thread of the stem.

Step 13. Replace the stopper, ensure the O-Ring is in place, then tighten the stopper. Do not overtighten.

Step 14. Fit the handle and cartridge back into the body and tighten.

USER MANUAL

Spare Parts

Product Code	Description	Components Included
TFT9005	Hard Spring to suit TFT9069	1 x Hard Spring
TFT9085	Knee Operated Spring only - [To suit TFT3500]	1 x Hard Spring
TFT9201	Flat brass spacer to suit knee op valve - [To suit TFT3500]	1 x Brass Spacer
TFT9300	Knee Op Wand only - [To suit TFT3500]	1 X Knee Op Wand
TFTLF9304	Cartridge only - [To suit TFT3500 / 35KIT]	1 x Cartridge, 1 x O-Ring, 1 x Flow Cup
TFT9305	Pedal only - [To suit TFT3600]	1 x Pedal, 4 x Screws, 4 x Screw Anchor, 2 x Bolt, 1 x Washer
TFTLF1015L / TFTLF1016L	TFTLF1015 lid / TFTLF10106 lid	1 x Valve Rubber Grommet, 1 x Cover Plate
TFTLF1015	TFTLF1015 body & cartridge	TFT1015 Valve
TFTLF1016B	TFTLF1015 and TFTLF1016 box	4 x [M4 x 40mm Countersunk Screws], 1 x Fixing Plate, 3 x [M4 x 8mm Buttonhead Antivandal Screws], 1 x Circular Grommet, 1 x Support Valve, 1 x Oval Grommet, 1 x TFT1015/6 Box
TFTLF9069	Adjustable cartridge	1 x Time Flow Cartridge

Troubleshooting

Problem	Cause	How to Fix
Tap is not shutting off	<ul style="list-style-type: none"> • Debris • Grease/ lubricant • High pressure 	<ul style="list-style-type: none"> • Is the cartridge tight • Have you flushed the water line for a minimum of 1 minute before connecting the water • Have you installed the strainer and flow controller if provided • If debris or lubricants have gone through the flow cup, it must be replaced. Debris or lubricants have a major effect on the hydraulic cartridge, this is more than likely to be the cause • Have you checked to make sure the pressure is to manufacturer's recommendations and in line with the plumbing code • Gecko rubber blown/peeled over due to high pressure
No water	<ul style="list-style-type: none"> • Isolating valve is off 	<ul style="list-style-type: none"> • Ensure the isolating valve is turned on
Run cycle is too long	<ul style="list-style-type: none"> • Need to order the right timing 	<ul style="list-style-type: none"> • The standard product is set to run for 4-6 seconds if the valve is with the fixed settings. However, if the handle has a hole for adjustment, then they can be adjusted from 2-40 seconds, for example: shower valve, pedal valve and bubblers • If you need different timing, you will need to order and replace the flow cup • If you have an adjustable time tap or valve, then you have the opportunity to adjust on site by just using an Allen key provided with every unit. The hole is located on the front of the handle, clockwise will reduce the time and anti-clockwise will increase the time
Issue with water flow	<ul style="list-style-type: none"> • Not enough water • Too much / little water 	<ul style="list-style-type: none"> • Check for blockage • Is the isolating valve fully open • Have got these in a bank, if so, is the inlet pipes been sized correctly • Has the flow control been installed • High pressure exceeding the plumbing code will have an effect on the product and must not exceed 500kPa • If flexi hose is used, ensure its not kinked/twisted

USER MANUAL

Problem	Cause	How to Fix
Not enough water	<ul style="list-style-type: none"> Taps installed in a bank or a trough 	<ul style="list-style-type: none"> Ensure the main pipe size is correctly sized to provide adequate water to service the taps installed in a bank or a trough
Knee valve and lever pillar tap won't shut off	<ul style="list-style-type: none"> The valve/ tap keeps running 	<ul style="list-style-type: none"> Please ensure the brass washer located under the handle and inside the dome is installed the right way round. Please refer to the instructions Ensure inlet/outlet is correct (follow the arrow)
How often do I need to service my tap	<ul style="list-style-type: none"> Prevent product failure 	<ul style="list-style-type: none"> Service and maintenance of the main operating parts is recommended as this will prolong the life of the product

Water Quality

Maximum chloride Cl- level Guidelines in plumbing systems

	Cold Water	Hot Water
Grade 304L	200	50
Grade 316L	1000	250

When materials may be used in either hot or cold water lines, the guidelines for hot water should be used.

Within these guidelines at ambient temperatures and provided the pH >~6, any negative effect to stainless steel will be unlikely.

Note: Chlorides in water - where the density of the solvent (water) is 1 (which it is to within 0.1% at ambient temperatures), then mg/L = ppm.

For brass products, please ensure the chlorine and chloramines levels are not more than 0.4 ppm.

Please ensure that the water quality supplied to the fixtures meets safe drinking standards to prevent potential staining of the product.

Chlorine guidelines (not to be confused with chloride)

- 304L suitable for chlorine levels up to 2ppm.
- 316L suitable for chlorine levels up to 5ppm.
- Short term dosing, for example 25-50ppm, for sterilisation purposes of 24-48 hours acceptable if effectively flushed through afterwards.
- Sterilisation is essential during commissioning of potable water systems.

Reference: <https://www.asda.asn.au/component/content/article?id=271:chlorine-and-chloride--same-element,-very-different-effect>

Responsibly Sourced



Reduce Carbon Footprint

GENTEC is rejuvenating the product- no power, less maintenance and longer life.

Rejuvenation Program

To learn more about the rejuvenation program, please contact our customer service at info@gentecaustralia.com.au for more information.

Ethically and Environmentally Sourced

Please refer to GENTEC Business Ethics & Ethical Sourcing Policy at <https://gentecaustralia.com.au/terms-and-conditions/>



A: Unit 6, 20-28 Ricketty St,
Mascot, Sydney, NSW 2020

E: info@gentecaustralia.com.au

P: +612 9319 4422

F: +612 8088 7635

Gentec products come with a Manufacturer's Warranty. To ensure the validity of this warranty, Gentec products must be installed following the provided installation instructions and adhering to AS 3500, NCC Volume Three, relevant Australian Standards, and any local authority requirements applicable to the product. Additionally, water and electrical supply conditions must meet the appropriate national and/or state standards. Non-compliance with these provisions may void the warranty and impact product performance.

Note: The information provided is only a guide, actual product may differ. The information here should not be relied on without clarification with Gentec. Gentec reserves the right to make design changes at any time without notification.

*Subject to terms and conditions. For detailed warranty information, installation compliance, maintenance and cleaning guidelines, and other relevant details, please visit <https://gentecaustralia.com.au>

gentecaustralia.com.au